

DON'T LET YOUR PROFITS GO DOWN THE DRAIN!



Drain Locks



Rooftop Solutions



Floor Sink Baskets



Drain Defender Fruit Fly Fighter

TOLL FREE: 1-844-564-9216



PREVENTATIVE PLUMBING &
DRAIN-LINE PROTECTION
DRAIN-TECH.COM
DRAIN-NET.COM



Green Drain Odor Sealer



Floor Drain Strainers

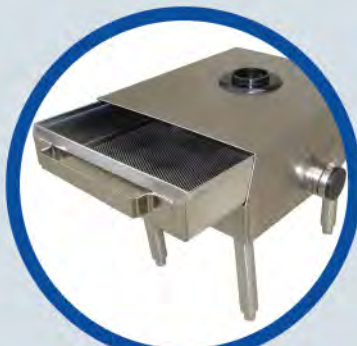

Grease Trap Pre-Strainers



Grease Traps



Not sure what you need?

Send us a picture of your problem drain and we'll ensure you get the right product in the right size. And remember...
measure twice, buy once!

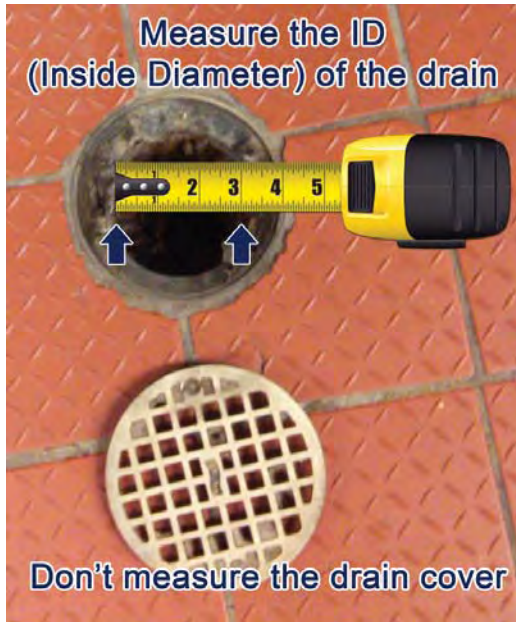

Frequent Drain & Grease Trap Servicing



Unattractive Roofs and Fire Hazards

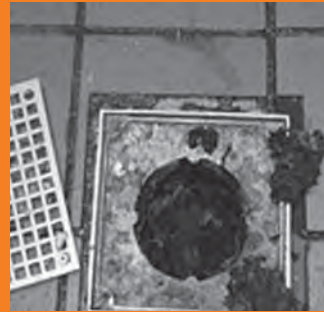

Foul Odors and Clogged Drains

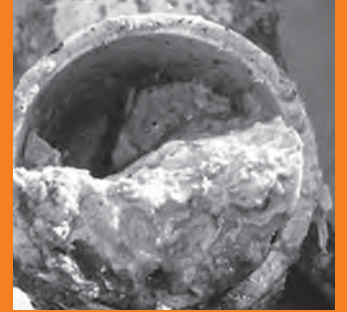

Expensive Facility Repairs



Flooded Floors, slip hazards, insurance claims



Dangerous Drain Cleaning Chemicals

Does your restaurant suffer from these symptoms?

10% OFF
YOUR PURCHASE



Valid at:

www.Drain-Tech.com

USE COUPON: 2015CATALOG

Limit one coupon per customer. Discount applied before sales tax and any shipping charges. Total amount of coupon must be redeemed at one time. Cannot be combined with any other offers, coupons, or discounts. Cannot be used for grease traps or automatic grease traps. Some additional exclusions may apply. Contact customer service for details. Coupon Expires 12/31/2015

Customer Satisfaction

At Drain-Net, customer satisfaction is our #1 goal. We stand behind the quality of our products and will make things right if you are not satisfied with your purchase. We believe that we can work together with our customers to make every purchase a positive experience. Our shipments are carefully inspected before leaving our warehouse, but in the event you are not satisfied with your purchase for any reason, you can return an item within 30 days of receipt for a refund of the merchandise purchase price, less a 15% restocking fee. Refund will be for the purchase price, in the original form of payment. Original delivery and handling charges are nonrefundable. Return shipping charges are the responsibility of the customer. Custom made items may not be returned.

Please follow these easy steps to return your unused item for refund or exchange.

1. Call 908-236-0277 and speak with one of our friendly Customer Service professionals. They will provide you with a shipping address to return the product.
2. Box up your merchandise in the original packaging if you have it. The goods should be well-packed so that we receive them in good condition. Please include a copy of your invoice or your contact information in the box. Customer is responsible for postage.
3. Please allow a minimum of 21 days for us to receive and process your return.
4. We will credit or refund the value of the merchandise total and any taxes you were charged (excluding delivery and restocking charges).



Drain-Net Technologies

PO Box 203
Stanton, NJ 08885

Toll Free Phone: 1-844-564-9216
Phone: 908-236-0277
Fax: 908-236-0278
Email: sales@drain-net.com

Contact our sales department regarding national accounts and large purchase orders.



Visit us on the web:
www.drain-tech.com
www.drain-net.com



Drain-Net Technologies is changing the way the restaurant industry approaches drain line maintenance. The large amount of food, grease, and debris found in a commercial kitchen makes restaurants highly susceptible to drain backups and plumbing emergencies. A “reactionary” approach to this problem is very costly and a major headache to restaurant staff. That is why Drain-Net has developed simple “preventative” solutions to solve common plumbing problems. With products that are safe easy to use, Drain-Net’s customers can dramatically reduce or eliminate drain backups, cleaning services, and costly repairs. Our non-chemical approach toward drain line maintenance is safer for the environment and staff. Restaurants also rely on Drain-Net for grease interceptors and related products. Drain-Net was founded in 2003 as a division of P.E.P. (Plastic Engineered Products) which specializes in plastic piping, valves, fittings, and other related products.

Get the Solutions here!

TABLE OF CONTENTS

- Page 4: Floor Drain Strainers
- Page 6: Green Drain Odor Sealer
- Page 7: Floor Sink Strainer Baskets
- Page 8: Grease Traps
- Page 10: Automatic Grease Traps
- Page 11: Rooftop Protection
- Page 11: Wireless Grease Monitor
- Page 12: Drain Locks
- Page 14: Drain Defender
- Page 16: Garbage Disposal Replacement Units
- Page 17: Grease Trap Pre-Strainer
- Page 18: Trench Drains
- Page 18: Facility Management
- Page 19: Drain Covers



facebook.com/drainnet



youtube.com/drainnet



twitter.com/DrainNetOnline



drain-netonline.com



pinterest.com/drainnet



Floor Drain Strainers

They quickly pay for themselves!

EVERY DRAIN NEEDS A NET

A Drain-Net strainer or drain sock captures food, trash, and debris that would otherwise clog your floor drains. Remove the dangerous (and expensive) chemical pipe cleaners in your kitchen and avoid repeated calls to the plumber.

- Prevents the need for drain jetting and costly repairs to piping system
- Prevents flooded floors which can cause shutdowns, slip hazards, and health code violations
- Reduces FOG (fats, oils & grease) and BOD (biological oxygen demand)
- Reduces sewer and drain flies
- Eliminates foul odors at the source

F.

ONE TURN TO OPEN



ONE TURN TO CLOSE



NEW!

“Easy Open Floor Drain Cover”

- One twist to open and close your drain cover
- Allows for easy access to your Drain-Net strainer
- Now you don't have to worry about losing screws
- 100% Stainless Steel

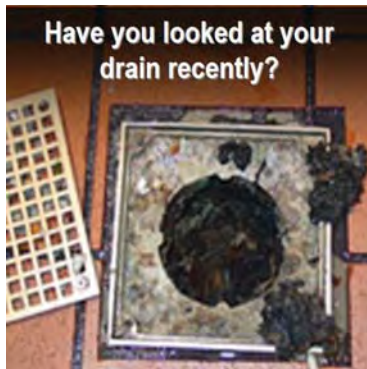

Flexible Drain Sock



A.

Disposable nylon mesh floor drain strainer which can capture most kitchen waste. Flexibility ideal for short, curved, or irregularly shaped drains.

Plastic Drain Strainer



B.

Ideal choice for most restaurant and commercial kitchen drains. Balances strength, durability, straining capacity, and affordability. Tapered for easy installation.

Stainless Steel Strainer



C.

Durable #10 mesh strainer ideal for finer particles. The 1/8” perforated strainer is ideal for frequent cleaning and industrial applications. Crossbar makes it easy to pull out of drains.

Solid Mesh Drain Sock



D.

Elastic nylon membrane bag ideal for catching sand, rice, sawdust, and other fine particles. Also ideal for construction sites.

Short Strainer



E.

Plastic strainer that captures larger debris and can also be used in conjunction with Drain Defender and Green Drain products

Custom shapes, sizes, and perforations available!



See inside front cover
for ruler

Floor Drain Strainers



HOW TO MEASURE FOR A DRAIN STRAINER

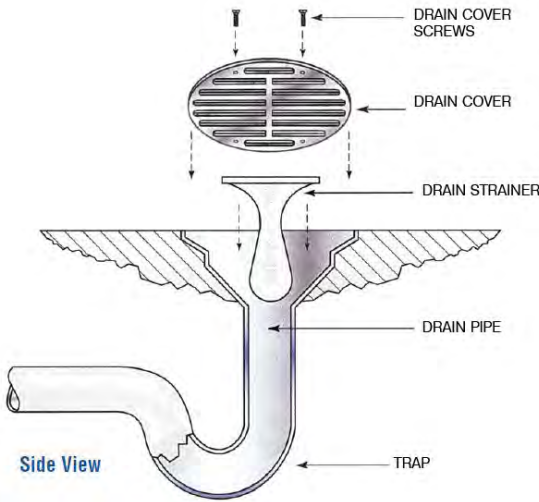

Drains come in all shapes and sizes; therefore, it is necessary to examine your floor drains before purchasing a Drain-Net drain strainer. Here are some tips:

- DON'T measure the drain cover. Remove the drain cover to view your drains.
- The shape and size of your drain will determine where the drain strainer should be located. Some will be placed directly under the drain cover, while others will be placed further down, close to the pipe.
- Measure the drain opening where you will place the drain strainer. Note that each drain strainer has about a 1/4" lip or edge to hold the strainer in place.
- If there is an internal dome strainer, remove it. We do not recommend using dome strainers because they are unable to catch and remove debris. Using a Drain-Net strainer allows you to catch and remove the debris.
- Determine how far down the trap (curve in the drain) is located. If there is a shallow trap we recommend the Flexible or Solid Mesh Drain Sock.

HOW TO MAINTAIN A DRAIN STRAINER

- Drain Strainers are a **preventative plumbing solution**; therefore, we recommend giving your floor drains a fresh start by getting them jettied. The drain strainers will prevent you from needing to jet your drains again.
- Remove the drain cover and insert your Drain-Net drain strainer.
- Monitor your drain strainer on a daily basis until you determine how often you should empty the strainer. Some strainers will capture so much debris that they should be emptied every few days. Other strainers go months before they need to be emptied.
- We offer an easy open drain strainer and a hinged drain grate to make accessing your drains even easier.

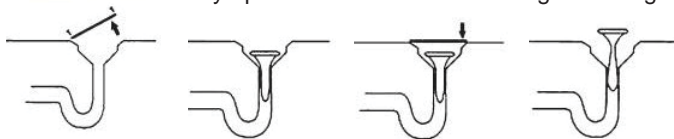

1. Remove existing floor drain cover

2. Insert Drain Strainer or Drain Sock into drain

3. Replace existing drain cover

4. Empty or replace Strainer / Sock when full

See page 19 for hinged drain grates



EASY-CLEAN DRAIN SYSTEM

Never before has cleaning your floor drains been as easy as replacing a coffee filter! All you need is a Plastic Drain-Net Strainer and a box of Filter-Nets. This system filters out all debris, while only taking seconds to maintain.

- 1) Insert Plastic Drain-Net into floor drain
- 2) Insert Disposable Filter-Net into Plastic Drain-Net Strainer
- 3) When Filter-Net is full, throw away and replace with a new one. No drain clogs, mess, or hassle.

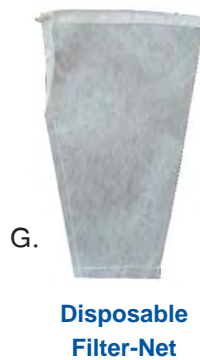

	Description	Drain Size	Length	Product Code	Price
A.	Flexible Drain Sock	2"	~9"	PDN020F	\$3.50
		3"		PDN030F	\$3.75
		4"		PDN040F	\$4.05
		6"		PDN060F	\$8.50
B.	Plastic Drain Strainer	2"	8"	PDN020PR	\$7.50
		3"		PDN030PR	\$8.50
		4"		PDN040PR	\$9.50
C.	Stainless Steel Drain-Net Strainer	2"	4"	PDN020S	\$60.00
		2"	6"	PDN020	\$62.00
		2"	9"	PDN020L	\$64.00
	Prices show for #10 Mesh. Add 10% for perforated strainers. Contact us for custom sizes.	3"	4"	PDN030S	\$66.00
		3"	6"	PDN030	\$68.00
		3"	9"	PDN030L	\$70.00
		4"	4"	PDN040S	\$70.00
		4"	6"	PDN040	\$74.00
		4"	9"	PDN040L	\$76.00
D.	Solid Mesh Drain Sock	2"	~8"	DNS020	\$2.50
		3"		DNS030	\$2.75
		4"		DNS040	\$3.00
E.	Short Strainer	3"	3"	DDS1-R4	\$8.50
F.	Easy Open Drain Cover (Round)	5"	NA	DD-R5	\$26.95
G.	Disposable Filter-Net, box of 60	3"	8"	PDN030FN	\$12.00
		4"		PDN040FN	\$12.50



Green Drain Odor Sealer



See inside front cover for ruler

BLOCK ODORS, HARMFUL SEWER GASES, AND FRUIT FLIES!

Traps provide a physical barrier between a building and the drainage system. Unfortunately they often do not receive enough drainage to maintain the water seal. This exposes your facility to dangerous sewer gases, odors, fruit flies, and pest infestation.

Drain-Net offers the most effective solution to this problem with Green Drains Super Seal. Green Drains seals off your facility from noxious gasses and creates a barrier to drain pests and the like. It is a simple alternative to a trap primer with no mechanical parts to replace or maintain.

Green Drains also solves the problem of evaporation water in infrequently used floor drain traps which has become more of a problem with the advent of waterless cleaning systems. The old solution use to be costly trap primers which require a great deal of service and can create costly maintenance problems.

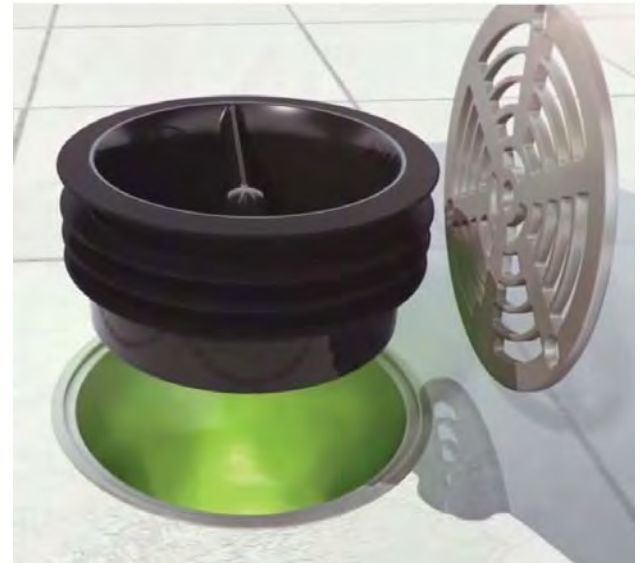
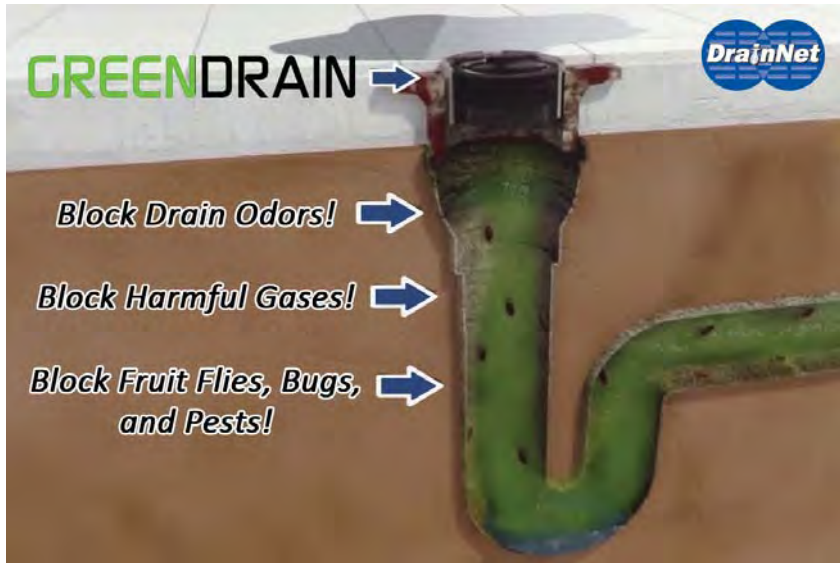

BOTTOM OF BODY



TOP OF STRAINER

The Green Drain can be used in the outlet connections of floor drain bodies or the inside of the floor drain strainers to seal the opening. The four flexible silicone sealing ribs ensure easy installation into openings that have variations in size. The Green Drain will open to allow drainage and close when there is no water flow. It can be used in new construction or retrofit applications where trap primers were never installed.

Description	Product Code	(A) Width	(B) Height	Price
2" Green Drain	GD102	2"	2"	\$39.95
3" Green Drain	GD103	3"	2"	\$42.95
3.5" Green Drain	GD1035	3.5"	2"	\$44.95
4" Green Drain	GD104	4"	2"	\$49.95

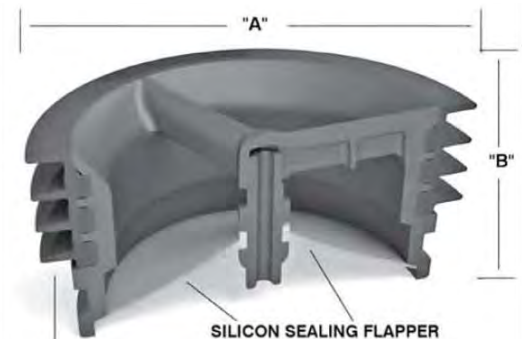

SILICON GASKET FLEXES .100" TO FIT DIAMETER

Floor Sink Baskets



BENEFITS OF A STRAINER BASKET

- Captures solids in a basket instead of clogging your drain lines or grease trap
- Prevents blockage and costly repairs to pipes before they occur
- Prevents flooded floors which can cause shutdowns, slip hazards, and health code violations
- Select models have slotted sides, so as the basket fills up, water flow doesn't slow!



A. Drain Edge

Don't let the floor sink be used as a trash can. Get the edge and protect your drains with this new basket featuring a 2" lip. Now staff can't sweep debris and trash into your floor sink basket. Custom edges available!

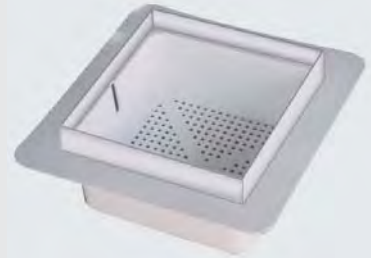

B. Plastic Floor Sink Basket

Best filtering basket you can find. Features four slotted sides and a slotted bottom for maximum water flow and straining capacity. Shown with handle for easy removal.



C. Round Internal Floor Sink Strainer

Round basket strainer with slotted sides and a slitted bottom for maximum water flow and straining capacity.

Mop Basin Strainer



Fits standard mop basins. Simply pour waste water into basin and filter out debris to prevent drain clogs.



E. Floor Sink Basket with Flange

Heavy duty plastic with strainer holes larger than the other baskets.



F. Floor Sink Removable Grate

Stainless steel 0.40 mm Mesh #14. Fits on top of the floor sink.



G. Scrap (Pre-Rinse) Basket

Use with 20"x20" dish rack. Also fits in standard 21 3/4" square pre-rinse sink



	Description	Size	Depth	Product Code	Price
A.	Floor Sink Basket with Flange & 2" Edge	8.5" basket with 11 3/4" flange	4"	DE20	\$40.95
B.	Plastic Floor Sink Basket Strainer	6.5" square 8.5" square	3.5"	DN65 DN85	\$19.25 \$19.95
	Plastic Floor Sink Basket Strainer with handle for easy removal	6.5" square 8.5" square	3.5"	DN65H DN85H	\$22.25 \$26.95
C.	Round Internal Floor Sink Strainer, plastic	6.5" diameter	3.5"	DN65R	\$17.50
		9.5" diameter	3.5"	DN95R	\$18.50
D.	Mop Basin Strainer, comes with 6 filters	21" x 21"	8"	DSM-100	\$55.00
	6 Replacement Mop Basin Strainer Filters	21" x 21"	NA	DSM-F	\$18.95
E.	Floor Sink Basket with Flange, plastic	8.5" basket with 11 3/4" flange	4"	D102-1118	\$24.50
F.	Floor Sink Removable Grate, stainless steel	8.5" basket with 11" flange	2"	SFL-10	\$26.90
G.	Scrap (Pre-Rinse) Basket, stainless steel.	Fits 20" x 20" dish rack	2.25"	D102-1125	\$153.50
		Fits 20" x 20" dish rack	4"	D102-1151	\$177.22
H.	Extend-O-Net to reach drain baskets (basket not included)	Custom length made to your needs	NA	DEN800	starts at \$30.00

CAN'T REACH YOUR FLOOR SINK BASKET?

GET THE EXTEND-O-NET!

H.



If you can't get under your cabinet or sinks to reach your floor sink basket add a plastic handle to your plastic strainer basket. Length made to your specifications.

Go to drain-net.com to view more stainless steel and plastic strainer baskets.

Grease Traps



GREASE TRAP HIGHLIGHTS

- Award winning flow control with cleanout and air intake
- Can accommodate continuous discharge at 104°C (220°F)
- Can support 440 lbs of pedestrian and light duty traffic
- Will not corrode, chip or peel, even under the most severe applications
- Flexibility of installation—can be installed in-floor, on-floor, or semi-recessed
- New quick connect latching system eliminates nuts and bolts on cover for select models. Large Capacity units feature recessed bolt holes and stainless steel screws instead of latching system.
- Recessing extension kits available
- Injected molded engineering eliminates seams and potential leaking and odors
- Manufacturer PDI Certification for GPM models: 4, 7, 10, 15, 20, 25, 35, & 50
- **10-year warranty!**



Ease of use



Easy Installation



Durability

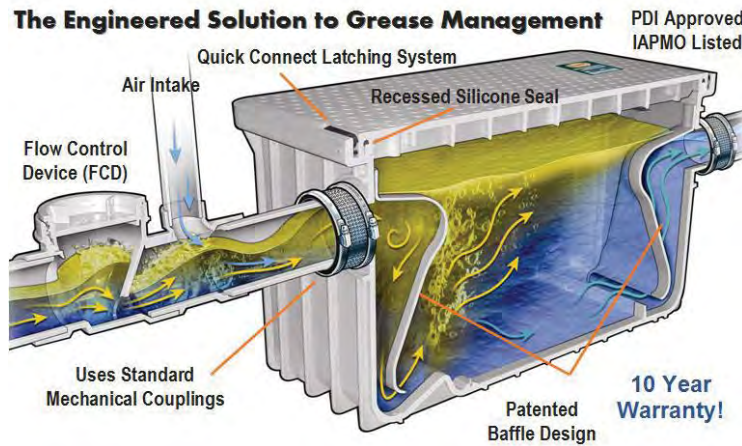

Plastic Grease traps are light-weight and highly durable.

		Ultra-Compact	Compact Grease Traps				Standard Sizes		
Flow Rate - US Gallons Per Minute (GPM)		4 GPM Model	7 GPM Model	10 GPM Model	15 GPM Model	20 GPM Model	25 GPM Model	35 GPM Model	50 GPM Model
Capacity	Grease Capacity (lbs) Actual	8	31.95	38.1	40.97	76.4	74	138.5	122
	Liquid holding capacity	2.3 gal	12.96 gal (49.06 L)	12.96 gal (49.06 L)	12.96 gal (49.06 L)	21.6 gal (81.8 L)	21.6 gal (81.8 L)	39.4 gal (149.1 L)	52.0 gal (197 L)
	Liters Per Second (LPS)		0.44	0.63	0.94	1.26	1.6	2.2	3.2
	Average Efficiency % (ASME 112.4.3)		95.5%	92.5%	92.0%	95.4%	92.5%	98.6%	93.9%
Dimensions	Length (in.)	15"	17.5"	17.5"	17.5"	23.6"	23.6"	31.0"	31.0"
	Width (in.)	10"	14.5"	14.5"	14.5"	17.5"	17.5"	23.5"	23.5"
	Height (in.)	9.5"	16.3"	16.3"	16.3"	16.3"	16.3"	17.5"	23.5"
	Bottom of unit to center of inlet / outlet	5.5"	12.8"	12.8"	12.8"	12.8"	12.2"	12.5"	18.5"
	Approximate weight	10 lbs	13.8 lbs	13.8 lbs	13.8 lbs	23 lbs	23 lbs	45 lbs	60 lbs
	Connection size	2"	2"	2"	2"	2"	2" or 3"	3" or 4"	3" or 4"
Model Number (*last two numbers indicate connection size)		D4804	D3907A02	D3910A02	D3915A02C	D3920A02	D3925A02* D3925A03*	D3935A03* D3935A04*	D3950A03* D3950A04*
Price		\$171.08	\$234.94	\$249.29	\$284.54	\$364.18	\$392.36 \$396.90	\$567.32 \$603.29	\$726.41 \$766.58

Custom sizes available. Give us a call!

Grease Traps



WHAT SIZE GREASE TRAP DO I NEED?

Determine the flow rate of your sink:

1. Calculate the capacity of the sink in cubic inches by multiplying length by width by depth. If you have multiple compartments or sinks, add the capacity of sinks together to find total cubic inches:

$$\frac{\text{Length}}{\text{Length}} \times \frac{\text{Width}}{\text{Width}} \times \frac{\text{Depth}}{\text{Depth}} = \text{Cubic Inches}$$

2. Convert the capacity from total cubic inches to gallons per minute (GPM) by dividing by 231:

$$\text{Cubic Inches} \div 231 = \text{GPM}$$

3. Adjust for displacement (displacement takes into consideration the actual usable capacity of your sink):

$$\text{GPM} \times 0.75 = \text{GPM}$$

4. Determine the flow rate and drainage period. Assume a 1 minute drainage period unless conditions permit a 2 minute drainage period. Drainage period is the actual time it takes to completely drain the fixture.

$$\frac{\text{GPM}}{\text{(1 or 2 min)}} \text{ drainage period} = \text{GPM (Flow Rate)}$$

5. Select interceptor from the table which corresponds with the flow rate calculated. Round up to the next largest size.

Compact Grease Traps

All new models use a development of our patented baffle system to enhance separation performance at low flow rates. Based on end user feedback, these units also feature the new EZ-Clean exterior tank profile, a non-ribbed section for the lower two inches.



Low Profile Grease Trap

With an 11 inch height the GI still meets the requirements of ASME112.14.3. Internal components can be removed in less than 6" of additional clearance making this unit a truly low profile solution.



Low Profile	Large Capacity Grease Traps						
25 GPM (low boy)	75 GPM	100 GPM	150 GPM	200 GPM	225 GPM	250 GPM	350 GPM
53.4	150	250	387	455	500	625	850 lbs
18.9 gal (71.54 L)	61.8 gal	112 gal	186 gal	225 gal	300 gal	405 gal	560 gal
1.6							
97.1%							
31"	44"	52.5"	52"	41.5"	53"	77"	77"
23.5"	25"	29"	32.5"	41"	41"	41"	41"
11"	24"	32"	42.5"	44.5"	49.5"	49.5"	61"
7"	20"	24"	35"	37"	45"	45"	57.5"
23.9 lbs	64 lbs	200 lbs	350 lbs	400 lbs	425 lbs	475 lbs	650 lbs
2"	3"	2", 3", or 4"	3", 4", or 5"	3", 4", or 5"	3", 4", or 5"	3", 4", or 5"	4", 5", or 6"
D3925A02LO	D4875	DAPGI-100	DAPGI-150	DAPGI-200	DAPGI-225	DAPGI-250	DAPGI-350
\$481.31	\$874.20	\$2,359.95	\$3,099.95	\$4,299.95	\$4,459.95	\$4,499.95	\$5,399.95

Custom Grease Trap

We can custom build grease interceptors engineered to your exact specifications and requirements. We also offer plastic pipes, valves, fittings, tanks, and much more.

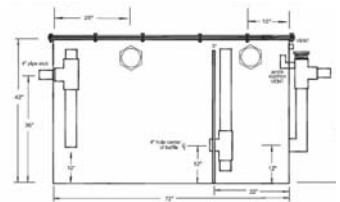



Automatic Grease Traps

How an Automatic Grease Trap saves you money

Installation Savings

Approximately 30% of existing foodservice sites cannot install large in-ground traps because of space restrictions or excessive site construction costs. These establishments are saving \$10,000-\$45,000 by installing an AGT.

Reduce or eliminate fines and repair costs:

Increasingly, sewer districts are implementing programs involving financial penalties to make commercial kitchen operators conform to community standards. Don't leave your facility vulnerable to such fines. A large hospital in the Northeast saved an estimated \$50,000 a year in fines and maintenance costs by installing a Big Dipper®.

Savings Year After Year

- Eliminate grease trap pumping costs
- Easily sell recovered grease

Example for a high volume Hamburger Restaurant:

Annual grease trap pumping costs:	\$1,200
Recovered grease sold for:	+ \$750
One year savings:	\$1,950

One nationally known fast food facility cut grease trap pumping costs by over \$25,000!

Savings may vary.

Drain-Net's Big Dipper® Automatic Grease Trap system solves tough free-floating drain water problems by removing and recovering up to 98.6% of the grease, oils, fats and incidental food solids from kitchen and food processing flows. Big Dipper® products help prevent drain line clogging and protect septic fields and on-site treatment facilities.

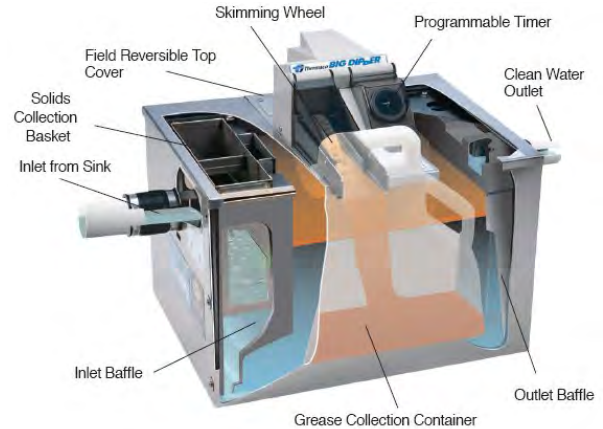

Big Dipper Internal Strainer (IS) Series

The Big Dipper Internal Strainer (IS) series utilize an internal strainer basket to capture incidental solids in kitchen waste water flows. A skimming wheel system inside the unit skims the grease & oils out of the retention area when activated by a programmable timer. IS units work well inside fast food-type restaurants or food preparation facilities where grease removal directly at the source is important.

- Fully automatic self cleaning cycle. Removes collected grease & oils from tank without any operator assistance. Comes with 24-hour timer and Grease Collector.
- Constructed of corrosion resistant materials suitable for installation in virtually any location. Attractive sanitary stainless steel exterior.
- Integrated Motor/Grease Outlet/Heater/Lid enables a fast, do-it-yourself unit operation reversal.
- Easy lift grease collector simplifies grease collection and emptying.
- Compact footprint makes installation possible in tight spaces.
- Two (2) No-Hub Connectors provided.

Point-Source Grease Removal

Smaller foodservice facilities such as fast food restaurants, schools, or cafeterias usually require Point-Source removal units. These units are typically installed directly at the source, usually at a three-compartment sink or a pot-washing sink. Point-Source Units easily fit under the drain boards at the three-compartment sink or pre-rinse station in the kitchen operation.



Fast Food Restaurant Field Test

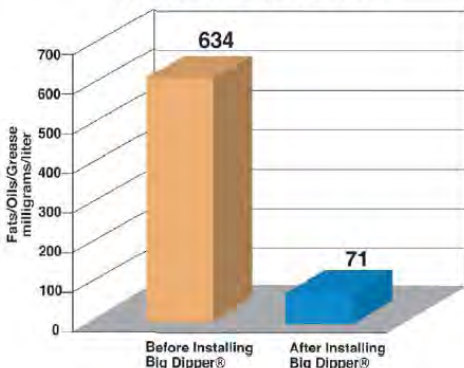

Attributes	W200-IS	W250-IS	W350-IS	W500-IS
Number of Skimming Wheels	1	1	1	1
Maximum Inlet Flow Rate	20 GPM	25 GPM	35 GPM	50 GPM
Material Interior	Rotationally Molded Polyethylene			
Material Exterior	304 Stainless Steel, Bright Finish			
Internal Solids Strainer Capacity	1.85 Gallons	1.85 Gallons	2.5 Gallons	2.5 Gallons
Grease Retention Capacity	40+ Pounds	50+ Pounds	70+ Pounds	100+ Pounds
Electrical	115 VAC, 60 Hz, 520 Watts (4.5 Amps)			
Skimming Rate	20 LBS Per Hour			
Price	\$2,975.00	\$3,275.00	\$3,450.00	\$3,975.00

There are also larger Grease Removal Units in the IS category that pretreat wastewater flows of 75 and 125 gallons per minute.

Rooftop Protection



A.

Fire Shield - The filter boom provides a fire-proof barrier that protects the roof & building from any potential exhaust system fire hazards. The filter is UV resistant and 100% biodegradable.

Durability - Constructed of the most durable V-O polymers, it is able to withstand harsh weather conditions and rugged treatment.

Omni Boom Absorbent - Made of hydrophobic materials to absorb grease but repel water. It also distributes the grease throughout the filter so that it can hold more grease.

Easy to Maintain - One filter design for quick and easy installation and maintenance. Installed directly to the fan curb, off the roof, and out of the way to allow rooftop service providers to be able to service the fan without standing on the unit.



As a food service provider your facility may be subject to unnecessary liabilities, rooftop safety hazards and code violations. Grease and oil emitted onto your rooftop by your kitchen exhaust fans result in unnecessary roof leaks, costly roof repairs, unsafe work areas and even worse— FIRE. Over 98% of all restaurant fires are due in part to kitchen exhaust grease and oil. A spark can travel through the exhaust system to the roof surface resulting in extensive damage to your property and investment.

B.



	Description	Product Code	Price
A.	Grease Gutter - 360 degree protection for low to moderate grease discharge applications	DNGG-400	\$750.00
	Grease Gutter High Capacity - 360 degree protection for high grease discharge applications	DNGG-800	\$799.00
	Fill-More Grease Gutter Boom - Replacement absorbent boom for the Grease Gutter and Grease Gutter Standard and High Capacity models	DNGG-RF	\$79.90
B.	Grease Gutter Sidekick - for low grease discharge applications or unusual ventilator systems	DNGG-Sidekick	\$186.43
	Grease Gutter Sidekick Boom - Replacement grease absorbent boom for Sidekick	DNFil-MorSKBoom	\$33.99

Grease Trap Monitor

TANK VISION: OUTDOOR GREASE MONITOR

The outdoor - remote, battery-operated tank monitoring system lets you know the sludge level on the bottom of a grease trap or septic tank, measures the temperature of grease or liquids, measures the floating grease and oil inside the tank, and alerts you to emergencies.

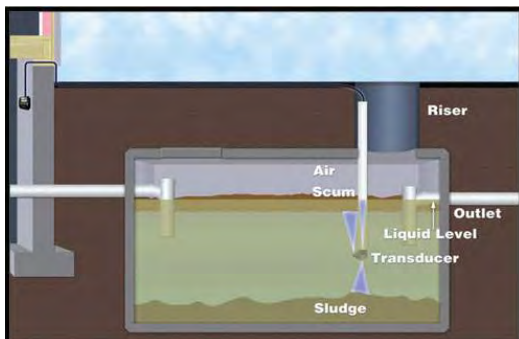

- ✓ **Get your pump schedule right!**
- ✓ **Recordable Data!**
- ✓ **Emergency Service Notification!**

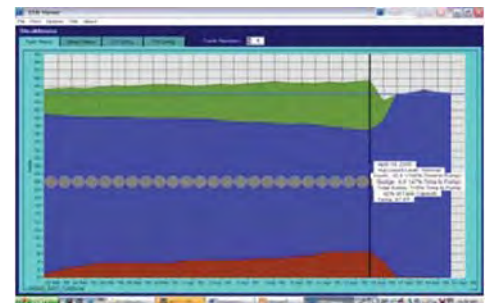

Description	Product Code	Price
Tank Vision - Outdoor Grease Monitor	DTV-100	\$2,500.00



Drain Locks

NEW! Guardian Drain Locks are now available with fine mesh!



Guardian Drain Lock for locking Floor Sinks

The Guardian™ Drain Lock is a new innovative device designed specifically for floor sinks and floor drains to protect unwanted debris from clogging and backing up your plumbing lines, which leads to costly expenditures.

Most drains do not come with the ability to screw or lock down the strainer. Staff and night cleaners are constantly removing, throwing away, and even stealing these strainers allowing debris to pass through the pipes. Plumbers are amazed at what they find clogged in the drain lines. **Common items such as silverware, raw meat, straws, trash, lemons, rags and other debris are often getting stuck within the P-Trap, drain lines, and the grease trap.**



If you can turn a socket wrench, you can install a Guardian™ Drain Lock in seconds



A. Guardian Drain Lock

Made of stainless steel, the Guardian Drain Lock is easily installed and locked within seconds to prevent staff or cleaners from removing it.

B.



Drain Locks utilize a security bit socket so that only you can unlock your drains. (Sold Separately)

Replacement Floor Drain Covers with locking features



C. Guardian FLOOR Drain Lock Square

- GDL-SFD-3500-S 4.57" Smith Style
- GDL-SFD-3500-Z 4.68" Zurn Style
- GDL-SFD-3500-J 4.52" Josam Style



D. Guardian FLOOR Drain Lock Round

- GDL-RFD-3500-S 4.70" Smith Style
- GDL-RFD-3500-Z 5.00" Zurn Style
- GDL-RFD-3500-J 4.65" Josam Style

See page 19 for more drain cover options!



See inside front cover for ruler

Domed Baskets Available Too!



E.



The Cross-strainer prevents large objects from entering the drain lines.



Dome-strainer catches smaller objects and debris without stopping up the drain lines.



Tamper-resistant screw deters removal of the dome strainer to ensure proper function.

Drain Locks

NEW! The LOCKING DOME Strainer

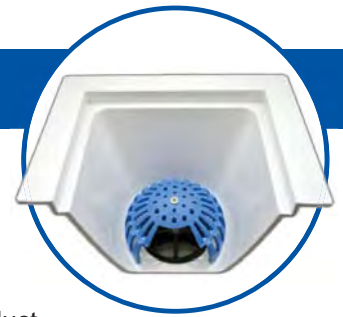

The Locking Dome Strainer Kit is a new product designed to protect your floor sinks to significantly reduce or eliminate drain cleaning costs.

- Keeps large debris out of your drain lines
- Reduces drain clogs, cleanings, and down times due to blocked drains
- Locked to prevent staff or cleaners from accessing drains.

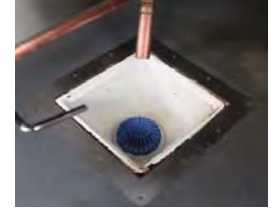

Lock & Stop for locking Floor Drains

F.

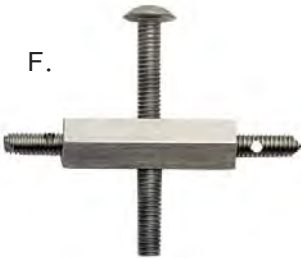

- The Lock and Stop™ locks your current drain strainer or screen to the end of the pipe with specially made hardware and provides you with a special drill bit to control who has access.
- This is the first and only drain locking device which does not require you to purchase new drain strainers.
- All parts are 100% stainless steel making it durable, corrosion proof, and virtually impossible to penetrate.
- Perfect solution when you have a uniquely shaped drain or need to keep your current drain strainer.

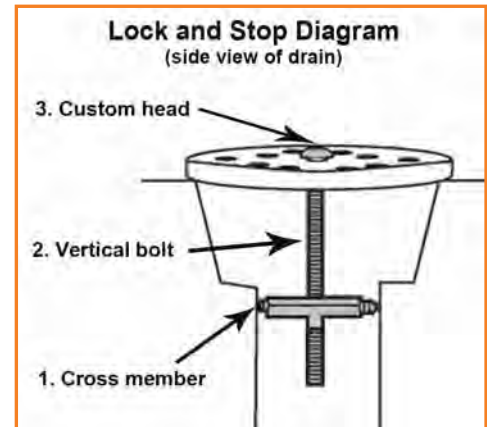

	Description	Drain Size	Product Code	Price
A.	2" Guardian™ Drain Lock, bit socket sold separately	2" drain	DGDL-2000	\$34.99
	3" Guardian™ Drain Lock, bit socket sold separately	3" drain	DGDL-3000	\$39.50
	4" Guardian™ Drain Lock, bit socket sold separately	4" drain	DGDL-4000	\$49.50
B.	Tamper-proof bit socket for 2" Guardian Drain Lock	2"	GDLOCK-2-T40	\$10.00
	Tamper-proof bit socket for 3" & 4" Guardian Drain Lock	3" & 4"	GDLOCK-34-T45	\$10.00
C.	3.5" Guardian FLOOR Drain-Lock SQUARE - Smith style	4.57" wide	GDL-SFD-3500-S	\$54.95
	3.5" Guardian FLOOR Drain-Lock SQUARE - Zurn style	4.68" wide	GDL-SFD-3500-Z	\$54.95
	3.5" Guardian FLOOR Drain-Lock SQUARE - Josam style	4.52" wide	GDL-SFD-3500-J	\$54.95
D.	3.5" Guardian FLOOR Drain-Lock ROUND - Smith style	4.7" wide	GDL-RFD-3500-S	\$54.95
	3.5" Guardian FLOOR Drain-Lock ROUND - Zurn style	5.0" wide	GDL-RFD-3500-Z	\$54.95
	3.5" Guardian FLOOR Drain-Lock ROUND - Josam style	4.65" wide	GDL-RFD-3500-J	\$54.95
E.	Locking Dome Strainer Kit	3" drain	LDome SK 3	\$42.95
	Locking Dome Strainer Kit	4" drain	LDome SK 4	\$47.95
F.	2" Lock & Stop™ Converter Kit (installation tool & security bit included)	2" drain	LS-020	\$39.20
	3" Lock & Stop™ Converter Kit (installation tool & security bit included)	3" drain	LS-030	\$41.44
	4" Lock & Stop™ Converter Kit (installation tool & security bit included)	4" drain	LS-040	\$43.68



Drain Defender



The Drain Defender product line uses proprietary compounds that will combat: Fruit Flies, Grease, Grime, Fats, Oils, Molds and Malodors

The Drain Defender line of products replaces expensive and often hazardous chemical products currently used in the industry to combat fruit flies, grease, grime, fats, oils, molds and malodors. These caustic products invariably do more harm than good. However, our Defender products consist of all-natural, eco-friendly proprietary compounds that will not damage your pipes or drain systems.

Moreover, when used properly in conjunction with each other, Drain Defender products will not only remedy the above issues, but also prohibit fruit flies from reproducing, thus eliminating them completely from the treated areas.

The Drain Defender line of products are light years ahead of any other cleaning and drain solution products on the market today and will save you time, money, and hassle when it comes to keeping your spaces clean and fruit fly free!

A. Defender Discs



Drain DEFENDER is a new and advanced drain conditioning system that replaces your existing floor drain cover with our unique, interactive, drain cover-basket system. The DEFENDER Discs abates fruit fly infestation and keeps drain lines free of fats, oils, greases, molds, and malodors.

B.

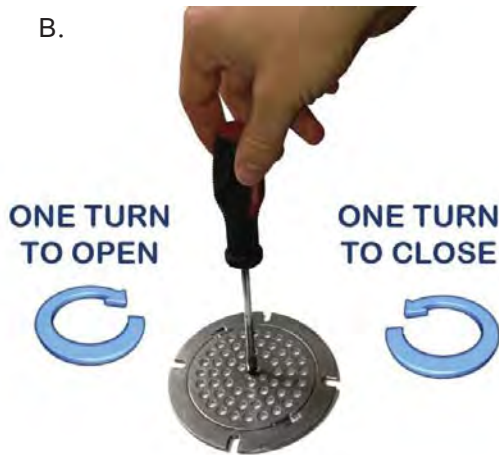

“Easy Open” Floor Drain Cover

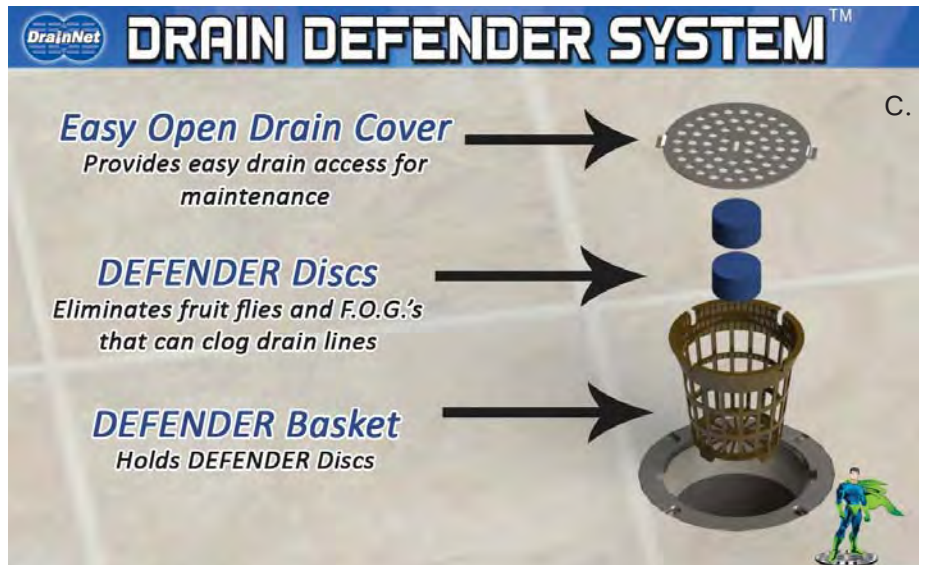

	Product	Description	Part Code	Price
A.	Defender Discs	Proprietary Bacterial Compound for floor drains - 14 pack	DCR-01	\$51.29
B.	Easy Open Drain Cover	5" round drain cover, made of stainless steel	DD-R5	\$26.95
C.	Drain Defender System	Easy Open Drain Cover & Brown Basket combo (Defender Discs sold separate)	DDS1-R5	\$30.95
	Small Brown Basket	Use this 3" basket to hold the Defender discs. For use in floor drains.	DDS1-R4	\$8.50
D.	Ultra Floor DEFENDER	5x concentrate formula - 64 oz. jug	UFD-08	\$16.64
		10x concentrate formula - 64 oz. Jug	UFD-09	\$27.77
		10x concentrate formula - 6 oz. sample	UFD-10	\$3.50
E.	Outbreak Defender	4-pack of 16 oz. bottles + 1 trigger spray	OBD-15	\$27.88

The Drain Defender products were tested in two of my stores for 60 days. I was surprised when even after the first few days of testing, we noticed a striking improvement to our drain system, our floors never looked better and after a week the fruit flies were completely gone.”

--Dennis, McDonald's Owner/Operator

Drain Defender



D. UltraFloor Defender



UltraFloor DEFENDER focuses on grease / food waste accumulating on the floor, in grout and cracks, around the drains, under equipment, and hard-to-reach areas. You will be amazed at how this cleaner cuts grease build-up, fatty acids and dirt. It reduces slippery floors too!

E. Outbreak Defender



All natural formula made from food grade ingredients! Contains NO Bacteria, NO Harsh Chemicals, and NO Enzyme! Spray in the air and watch fruit flies fall to their death! No messy residue and the peppermint oil fragrance is refreshing.

F. Fruit Fly Fighter



The Fruit Fly Fighter eradicates fruit flies in hard to reach and concentrated areas of fruit fly population. Spray our proprietary, bacteria based, eco-friendly product on your non-food contact surfaces and let Fruit Fly Fighter wage war on your dirt, grime, grease, and fruit flies!

G. Sink Defender



Sink DEFENDER is a small plastic ball filled with the same proprietary compound as our Drain Defender System. The Sink Defender is an effective release mechanism to prevent fruit flies, remove odors, and keep drain pipes clear.

H. Floor Sink Defender



The FloorSink Defender is a specially engineered device that is designed to fit within your floor sinks. It takes advantage of our proprietary compound to eliminate fruit flies, oils, fats, greases, and odors that can cause problems. This slow release system keeps working for weeks!

J. Beverage Tray Defender



Put the proprietary disc in your beverage tray. As ice melts or liquids flow over the disc, the slow-releasing disc releases the proprietary bacterial formula throughout the drain line. The active bacteria eliminates fruit flies, mold, odors, and can even clean up the drain line.

K. Beer Tap Defender



Did you know that all beer tap dispensers promote the growth of harmful bacteria? Our Beer Tap Defender discs use an all-natural eco-friendly formulation to eliminate cold water mold and clean your drain lines. They even help eradicate fruit flies and foul odors.

I. Soda Nozzle Cleaner



Give your customers a germ-free soda with our NEW Nozzle Cleaner Dissolving Action Formula! Cleans and eliminates germs while nozzle parts are soaking. Will not crack / deteriorate or harm your nozzle parts like bleach cleaners and works better than soda water.

	Product	Description	Part Code	Price
F.	Fruit Fly Fighter	Starter kit includes (1) 32 oz. spray bottle + (1) 6oz. concentrate formula	FFF-13	\$21.26
		6 oz. concentrate for refills (concentrate)	FFF-14	\$4.25
G.	Sink Defender	Package of 3 small plastic ball with compound	SBD-03	\$11.81
H.	Floor Sink Defender	Large defender compound disc in a slow release devise - 1 pack	FSD-04	\$8.60
I.	Beverage Tray Defender	Defender discs to clean out beverage tower drain line - 6 pack	BTD-06	\$21.16
J.	Beer Tap Defender	Defender discs to clean out beer tap drain lines - 12 pack	BTD-07	\$20.11
K.	Soda Nozzle Cleaner	16 oz. jar powdered formula of Nozzle Cleaner	SND-23	\$12.55

Garbage Disposal Replacement Unit

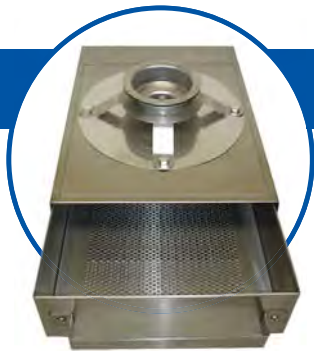

In food preparation establishments, the garbage disposal does a very thorough job of mixing freshwater with ground food waste and FOG, increasing the burden of grease trap/interceptor which is designed to separate water from grease. This is why using the garbage disposal to grind food waste is not a part of the Best Management Practice. Because of this, more and more City Halls and local Water Districts have restricted or even prohibited the continued usage of commercial garbage disposals.

Instead of grinding the food waste and wasting precious freshwater for flushing, the strainer-drawer in GDRU strains solid particles under the pre-rinse sink when dirty dishes are being pre-rinsed, affecting a much needed pretreatment process of restaurant wastewater. To ensure the food waste is not flushed down your drains, install our GDRU to catch any solid waste before it enters the piping system and grease trap/interceptor. This will help to eliminate the backflows and the foul grease trap/interceptor odors, and costly repairs to your pipes.

REASONS TO REPLACE YOUR GARBAGE DISPOSAL

- Zero danger to employees. Garbage disposals present a clear and present danger to kitchen staff. These units are designed to indiscriminately grind up anything coming into contact with grinding or cutting heads.
- Saves money on water and electricity
- Keeps grease trap cleaner, which lowers maintenance frequency
- Encouraged (or required) by local governments and Water Districts
- No moving parts to constantly maintain or repair



Motorized garbage disposals are outlawed in most states



Filter solid food debris out of water

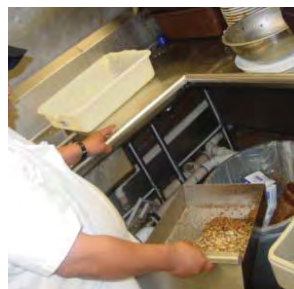

Pull out waste drawer and empty when full



Install a GDRU and watch your plumbing costs drop!



A.

Standard GDRU

This model is suitable for small to medium-sized restaurants. The top of the unit ranges from 25-1/2" to 30-1/2" above the floor, fitting the standard 34" height pre-rinse table with a 5" to 8" deep bowl. The Crown Adaptor guides wastewater with very small particles from the pre-rinse sink into the strainer-drawer of the unit.

Large Capacity GDRU

This model is for high volume operations in heavy waste areas, large commercial complexes, hotels, restaurants, food processing facilities, and cafeterias. The top ranges from 25-1/2" to 30-1/2" above the floor. It fits the standard 34" height pre-rinse table with 5" to 8" deep bowl.

B.



GDRU Description:	A. Standard	B. Large Capacity
Product Number	GDR-A16	GDR-A18
Sink opening size	up to 9"	up to 9"
Location of Outlet	Bottom	Either side
Drainage Required	Floor or wall	Floor or wall
Mounting Requirement	No	No
Adaptor Provided	Crown adaptor	Crown adaptor
Unit is supported by	3 legs	4 legs
Inlet is connected to	Sink opening	Sink opening
Type of Installation	Off-the-floor	Off or on-the-floor
Price	\$409.95	\$529.95

Did you know that as solid waste collects in your grease trap the capacity is diminished, decreasing its ability to separate and capture grease, even to the point of complete ineffectiveness?

Grease Trap Pre-Strainer



← A Pre-Strainer filters wastewater debris

BEFORE

wastewater reaches the Grease Trap. →



One of the primary causes of drain clogging and backflow in restaurants is the waste and debris that comes from food preparation and ware-washing sinks. These grease trap pre-strainers intercept 98% of solid particles from wastewater before they reach your drains, grease trap, and facility piping.

- Removable tray allows user to empty solids into a trash receptacle in seconds
- One unit can handle multiple sinks (up to 18 gallons per minute)
- Adjustable height for easy installation
- 2" connection from either side
- Durable stainless steel construction



- ✓ Prevents drain line clogs from commercial sinks
- ✓ Improve the efficiency of your grease trap
- ✓ 25% more straining capacity than previous models
- ✓ Works as Direct or Indirect Wet Waste Interceptor
- ✓ Built rock solid - 100% Stainless Steel

FINE PARTICLE STRAINER

Did you know – an average restaurant will wash almost 2 pounds of solids down the drain daily, if not more! The R2 Fine Particle Strainer (FPS) is a high quality, but low cost and low maintenance system that removes 99% of food or organic debris particles from all sink fittings before they pass into the drainage system. The reduction in solids means dramatically reduced; blockages, foul odor, corrosion, expensive reactive plumbing, high pumping frequency and surcharges from municipal water authorities.

- Reduces BOD (Biological Oxygen Demand) and TSS (Total Suspended Solids)
- Reduces Plumbing Blockages and Drain Line Odor Problems
- Reduces Corrosion and Acidity
- Reduces High Frequency Pump Outs
- Improves Grease Trap Performance and Saves Money
- Lowers Risk of receiving Sewer and Wastewater Fines and Surcharges

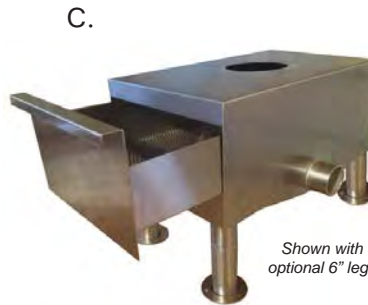

Drain-Net A6 Flat Strainer

This model is for a wall or floor drain connection. Can be used for 3-compartment sinks, dishwashing or food prep sinks. Only 10" tall! Can be 16" tall with 6" leg extensions.



Pre-Strainer for 6 - 9" sink opening

Equipped with 10"-15.5" adjustable legs. The top of this unit ranges from 19.5"- 25.5" above the floor and can be installed before the grease trap. 18 gallons per minute.



Micro-Filter captures wet waste

	Description	Product Code	Price
	Drain-Net A6 Flat Strainer	GDR-A6	\$399.95
C.	A6 Flat Strainer 6" Leg extensions	GDR-A6LX	\$49.50
	Fine Mesh Strainer Drawer Insert: capture rice and other fine particles	GDR-A6FM	\$75.00
D.	Grease Trap Pre-Strainer for sink opening 6" – 9" use	FPS-610C	\$369.95
E.	R2 Fine Particle Strainer	R2-FPS	\$249.99
F.	R2 Fine Particle Strainer (FPS) Filter replacements (box of 30)	R2-FPS Filter	\$22.50

Trench Drains

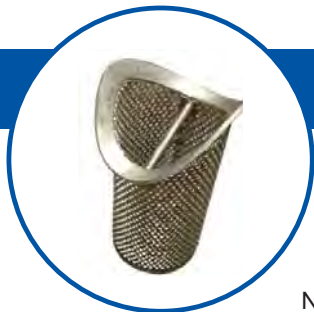

LOCKING TRENCH DRAIN STRAINER

Now you can lock down your trench drains by combining our Lock and Stop Drain Lock with our one of a kind trench drain outlet. Fits 4" wide x 2.75" tall U-shape trench with 3" drains.

A.



side view

top view

Also available with a stainless steel outlet

B. **NEW!** TRENCH DRAIN STRAINER INSERT

Place into trench drain. Fits most 3" drains. Custom lengths and sizes available.



Don't let your trench drain look like this!



Facility Management

COMMERCIAL DRAIN BRUSH

C.



- Clean your drains and scrub the walls of your pipes to effectively remove grime buildup and bacteria. Cleaning also prevents a common breeding ground for fruit flies.
- 36" flexible wire allows brush to easily access hard to reach floor drains
- New splash guard ensures that anything splashing out of the drain on removal hits the bottom of the splash guard and not the user's clothing, shoes, or the surrounding floor.
- Polypropylene bristles and three wire twist design ensures the brush doesn't fall apart. Single bristle design for max strength and cleaning power.
- Poly Ball on the end to guide smoothly through elbow turns in drain pipes



D.

ICE WAND



The average ice machine cleaning cost is over \$200. In high yeast environments, such as baking bread or pizza, ice machines may require monthly cleaning. Maintaining a higher standard of water quality by implementing the Ice Wand technology allows you to: cut costs, reduce down time, and extend the life of your ice machine with the Ice Wand!

- EPA registered to control bacteria and slime and certified by NSF International against ANSI/NSF STD42 material requirements
- Controls the growth of slime in your ice machine, enhancing the quality of your ice cubes and beverages
- Easy one-step drop in installation and is compatible with most major ice machine models
- Reduces maintenance costs
- Non-toxic and environmentally safe. Dispose with normal trash (suggested replacement every three months)

E.

URINAL DRAIN BASKETS

- Eliminates clogged urinals
- Built in odor fighting ingredients
- Deodorizing cherry fragrance
- Fits American Standard # 6541 & 6050 urinals





See inside front cover
for ruler

Drain Covers



F. UNIVERSAL FLOOR REPLACEMENT DRAIN COVER

- Replace rusted or broken cast iron strainers or bar grates
- Heavy gauge stainless steel making it 100% corrosion proof
- Adjustable screw grips to fit almost any drain size.
- A screw driver is all that is required to install.
- Gripping fingers fit snugly inside pipe keeping strainer securely in place
- Measure the ID (inside dimension) of the drain to determine size.



Secure your
drain cover with
a Lock & Stop!

G. HINGED FLOOR DRAIN GRATE

- Eliminate the cost and danger associated with loose or missing floor drain grates.
- Unique hinged design allows for easy access drain cleaning.
- Tamper proof screws prevent grates from being removed and misplaced.



H. FLOOR SINK REPLACEMENT GRATE

- Replace your rusted or broken floor sink grate
- Lightweight, durable, and corrosion resistant
- Engineered to conform to strict plumbing codes
- The PVC surface will not chip, rust, or corrode



	Product	Description	Part Code	Price
A.	Locking Trench Drain Strainer	Durable plastic outlet with 4" stainless steel Lock and Stop	TDS-600	\$90.00
		Stainless Steel outlet with 4" stainless steel Lock and Stop	TDS-650	\$125.00
B.	Trench-Drain Strainer Insert	Fits most 3" drains. Custom lengths and sizes are available.	TDS-500	\$75.00
C.	Commercial Drain Brush	36" flexible wire brush to easily clean drains and unclog debris in P-Trap.	DB001	\$29.99
D.	Ice Wand	Controls the growth of slime in ice machine	IW2	\$59.00
E.	Urinal Drain Baskets	Fits American Standard 6541 & 6050 urinals	D13557	\$14.50
F.	Universal Floor Replacement Drain Cover	7 1/4" diameter, Fits 3 1/4" – 6 3/4" drain openings	DN847-7B	\$31.82
		9 1/4" diameter, Fits 5 1/4" – 8 3/4" drain openings	DN847-9	\$52.49
		Add a Lock & Stop to lock down your drain cover!	<i>See page 13</i>	
G.	Hinged Floor Drain Grate	5" round	1102-1152	\$42.99
		6" round	1102-1153	\$52.99
		7 3/8" square	1102-1135	\$139.99
		Tamperproof screw tool	142-1522	\$14.65
H.	Floor Sink Replacement Grates	9" x 9" Full Grate	D394709A	\$23.53
		9" x 9" Three Quarters Grate	D394709B	\$23.50
		9" x 9" Half Grate	D394709C	\$25.67
		12" x 12" Full Grate	D394712A	\$32.75
		12" x 12" Three Quarters Grate	D394712B	\$32.50
		12" x 12" Half Grate	D394712C	\$29.33

What's going down your drains?



Lower your repairs and maintenance expenses.

Cut all unnecessary expenses and start using Drain-Nets in your drains.

For approximately \$50 per store, this "one time purchase" can save you thousands of dollars and permanently eliminate your ongoing drain cleaning expense. You will also be reducing your exposure to slip and fall accidents that are commonly caused by flooded and wet floors. We suggest advising your insurance carrier that you have taken these proactive safety steps.



**Drain-Net
Technologies**

**PO Box 203
Stanton, NJ 08885**

Toll Free Phone: 1-844-564-9216

Phone: 908-236-0277

New Website: www.drain-tech.com

Website: www.drain-net.com

Email: sales@drain-net.com



Major credit cards accepted

**Contact our sales department
regarding national accounts and
large purchase orders.**